



Retro-Line®

Internal Freeze Protected Water Supply Systems

Installation Instructions

General Information

Retro-Line systems are an internal (in-pipe) freeze protected, potable, domestic water supply line systems adaptable to ALL areas where natural frost protection cannot be achieved. These are high performance products designed to work in cold and harsh environments. Retro-Line products are uniquely adaptable to many types of applications. System requirements will vary a great deal in accordance to ground conditions.

It is recommended that the Retro-Line installation be made by a qualified tradesperson. This will ensure that optimum performance is achieved in each installation. Variables include: retro-fitting of existing pipes - shallow buried in ground or rocky geography especially where thermostatic control is not possible - free air installations above ground and insulated - with or without thermostatic control.

Thermostatic controls and timers are optional but should be considered for every application for further energy savings if applicable. The use of insulation should also be considered for cold weather reliability and energy efficiency.

- A. This heating cable set shall be installed in accordance with the National Electrical Code (USA) or the Canadian Electrical Code.
- B. It is imperative that for all installations where the pipes are exposed to the outside ambient temperature that weatherproof insulation be used. (Wall thickness ½ inch minimum). Heat-Line offers closed cell foam types, foil/air bubble type and others. Other types of weather-proof insulations may also be used.
- C. Retro-Line can be used even when there is no water in the pipe. Retro-Line WILL NOT melt your water pipe. In the event of power failure your system may freeze. The system will however re-energize immediately following power restoration and will thaw out again. In most cases no damage to pipes will be encountered.
- D. When installing in metal pipes, always be sure that there are no sharp edges and pipes are properly reamed smooth

Retro-Line is a technically advanced product. Handle it with proper care and be sure not to damage the outer sheath or jacket of the cable.

Read the Safety Instructions and Installation Instructions completely before installing this product.

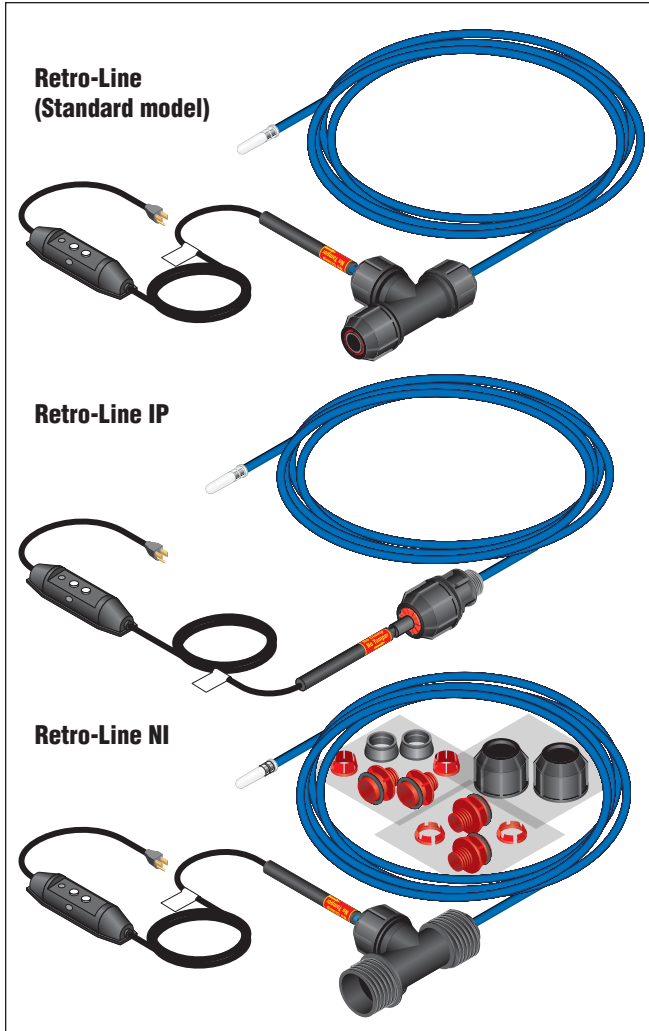

Approvals



Usage P and X
Installation Type D USA

Table of Contents

Retro-Line Standard Installation	2	Control Devices and Insulation Installation	16
Retro-Line IP Installation	6	Weighting/Ballasting Water Pipes in Lakes	17
Retro-Line NI Installation	10	Limited Warranty	18
Electrical System Connection	14	Extended Warranty Application Form	19

⚠ WARNING:

Important Safety Instructions and Rules for safe Installation and Operation

- A. Read these rules and instructions carefully. Failure to follow them could result in serious bodily injury and/or property damage.
- B. Check your local building, plumbing and electrical codes before installing. You must comply with their rules. Retro-Line is cCSAus Drinking Water NSF/ANSI 61 approved for use in Canada and the USA.
- C. Before installing this product have the electrical outlet checked by an electrician to make sure it is properly installed and grounded.
- D. Do not install the Retro-Line tee connection junction point in a manner that would render the system non-serviceable.
- E. Do not bury the connection point underground or in a location that may become flooded.
- F. Before installing or servicing your Retro-Line BE CERTAIN that the power source is disconnected.
- G. Do not use extension cords.
- H. Heat-Line does not recommend the use of non-certified or non-industry standard polyethylene pipe when using the Retro-Line standard model or Retro-Line NI. The Philmac compression fittings supplied as part of the Retro-Line Standard and NI model products are cCSAus certified for use with certified polyethylene pipes. If non-certified or non-industry standard piping is installed, such as thin wall polyethylene, a licensed trades-person should observe the installation and certify that the Philmac fitting has made a secure compression.
- I. Pressure testing the system prior to service is highly recommended to ensure a proper connection.
- J. Retro-Line is NOT approved or designed for use in sewer or waste systems. For sewer and waste systems use Heat-Line Paladin, EXT Series, Retro-DWS, Retro-FM or CARAPACE systems.
- K. Never tamper with or alter the electrical apparatus associated with your Retro-Line system.
- L. Check unoccupied residences regularly to ensure that all systems are operating properly.

WHEN PERFORMING WORK OR REPAIRS ON YOUR WATER SYSTEM BE SURE TO UNPLUG YOUR RETRO-LINE SYSTEM FROM THE POWER SUPPLY.



Retro-Line® (Standard Model)

Internal Freeze Protected Water Supply Systems

Installation Instructions



Description

The Retro-Line standard model is supplied with a compression tee fitting of a specific size to interface into ID or OD polyethylene pipe. Fitting for OD polyethylene pipe is available in CTS and IPSOD sizes. Pipe size must be determined at time of order. See part numbers below.

Kit Contents

Qty	Description
1	Retro-Line – Predetermined length (GFC shown)
1	Optional Cord-Set (CS) power connection

Optional Accessories

HLJ-STAT	NEMA 1 General Purpose 120V only plug-in Thermostat
HLA-120	NEMA 1 General Purpose 120V only plug-in Thermostat
GFA-STAT	NEMA 4X Ground Fault Protected Adjustable Thermostat 120V/240V 30 amp
MA-10	GFCI/ELCI Electrical Equipment Protection Device
INSUL-1.00	Closed cell polyethylene insulation sleeve for 1" ID pipe (6' long, 1 5/8" ID, 3/4" thick wall)
INSUL-1.25	Closed cell polyethylene insulation sleeve for 1 1/4" ID pipe (6' long, 1 7/8" ID, 3/4" thick wall)
INSUL-2.00	Closed cell polyethylene insulation sleeve for 2" ID pipe (6' long, 2 5/8" ID, 3/4" thick wall)

Retro-Line Ordering Chart

Example: RL - 125 - 100 - CTS - GFC	
Product	Cord-Set Type
RL 120 volt Retro-Line	GFC Ground fault protected 5-15P 120V / 6-15P 240V
RL2 240 volt Retro-Line	CS Cord connected (No GFCI)
Pipe Size	Pipe Size Type
075 Pipe size 0.75"	ID Internal Pipe Diameter I.D.
100 Pipe size 1.00"	CTS Copper Tubing Size
125 Pipe size 1.25"	IPS Outside Dimension I.P.S.O.D.
150 Pipe size 1.50"	Length of Heater
200 Pipe size 2.00" *	6 - 230 feet 3 watt /120V systems
	6 - 550 feet 3 watt /240V systems

* ID and ODIPS pipes only

NOTE: The heating cable is measured and cut to the length of system ordered. Some of this length will remain within the interface fitting.

Retro-Line Standard Installation

1

- Carefully remove your Retro-Line system. It comes complete with all parts as required pre-assembled, enclosed inside of the reel. Units less than 40 feet not supplied on reel.

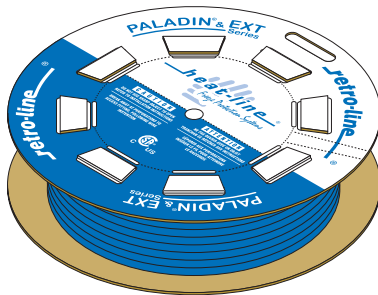

- It is recommended that a single circuit (15 amp) be installed by a qualified electrician for dedicated use of the Retro-Line system. **Do not use extension cords.**

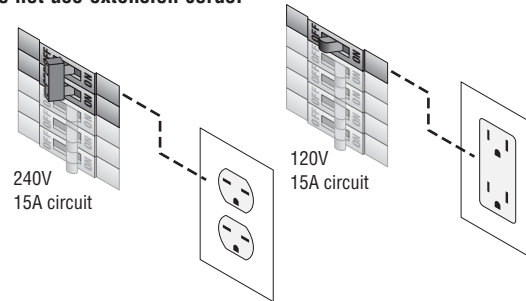

2

- Determine point of entry into the pipe. Your Retro-Line system is ordered by system (pipe) length. (See Retro-Line Ordering Instructions on page 2).
- Cut out a section of the pipe to gain access, preferably on the inside of the building and near your power supply. (Reference chart below)

CAUTION: Care must be taken not to cut the pipe too short as it is necessary to draw the pipe into the fitting when making a joint.

Pipe Diameter		Section of pipe to be removed
3/4"	ID	6 1/4"
1"	ID	6 1/4"
1 1/4"	ID	6 1/4"
1 1/2"	ID	6 1/2"
2"	ID	7 1/2"
3/4"	CTS/IPSOD	As per "PIPE ↑ STOP" lines on tee
1"	CTS/IPSOD	As per "PIPE ↑ STOP" lines on tee
1 1/4"	CTS/IPSOD	As per "PIPE ↑ STOP" lines on tee
1 1/2"	CTS/IPSOD	As per "PIPE ↑ STOP" lines on tee
2"	IPSOD	As per "PIPE ↑ STOP" lines on tee (IPSOD only)

Note: Do not install the Retro-Line tee connection junction point in a manner that would render the system non-serviceable. Consult Heat-Line with questions regarding installation parameters with respect to serviceability.

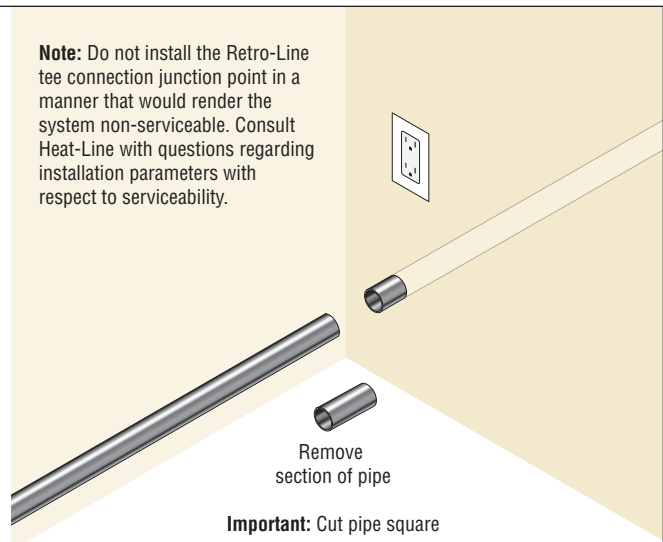

3

- Short Retro-Line systems may be pushed in without the use of a fish tape or rope. Longer systems may require the use of a fish tape or other installation method. For long systems a vacuum can be used to draw a sponge "mouse" through the pipe with a 1/8" mason line attached. These sponges can be hand made or purchased from Heat-Line. Extra long systems may require "cutting in" a coupling or series of couplings to provide access points to pull in the Retro-Line. When this is required it is important to use a Philmac® coupling furnished by Heat-Line.
- A 6 foot leader is provided with all Retro-Line systems over 90 feet. This leader is your point of attachment for pulling in the Retro-Line. If the leader is not required, remove it and simply push in the Retro-Line into the pipe.
- A non-toxic, water based (potable) lubricant can be used to make cable insertion or pushing of long lengths easier.

NOTE: Retro-Line systems in reasonably straight runs up to 150 feet can most often be pushed all the way in without pulling. The Retro-Line leader is only provided as an aid to pulling. It is unable to withstand extremely hard pulls and will break if overstressed. Heat-Line will not be responsible should this occur.

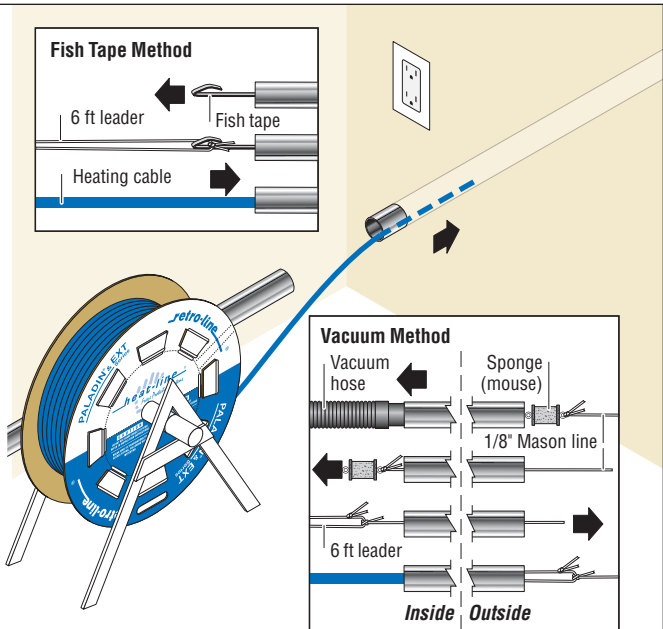

4

- Slowly push/pull the Retro-Line into the pipe off of the reel. Upon total heater insertion, break open the reel at perforations, or lift tabs to remove lid as shown. **Do not use sharp instruments.** Finish insertion of the Retro-Line until the Philmac fitting comes up tight.

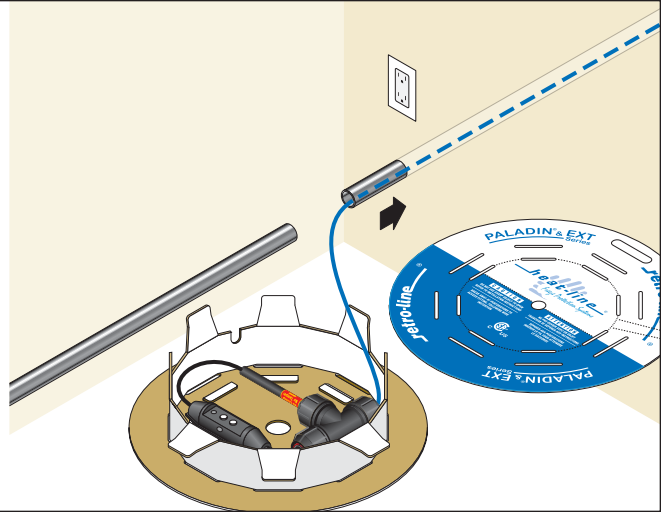

5

- Install Philmac fitting onto pipe. (Refer to installation steps **5A** for ID pipe applications or **5B** for CTS/IPSOD pipe applications). (1" ID Philmac fitting shown.)

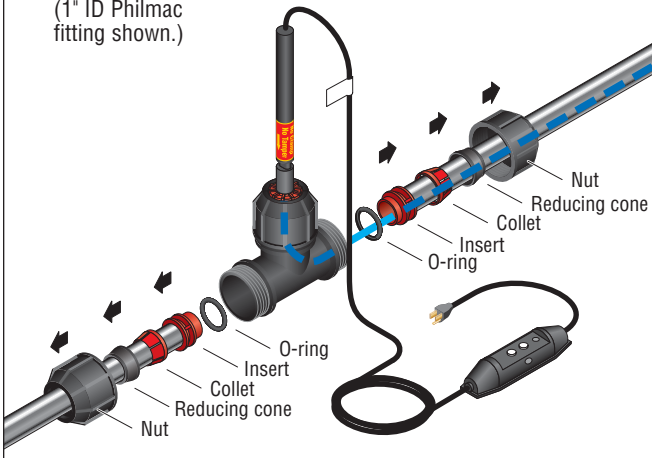

5.1A Installing an ID Philmac Fitting

- Remove nut and split collet from central fitting and slide over pipe.

NOTE: Ensure the taper or split collet faces toward the nut.

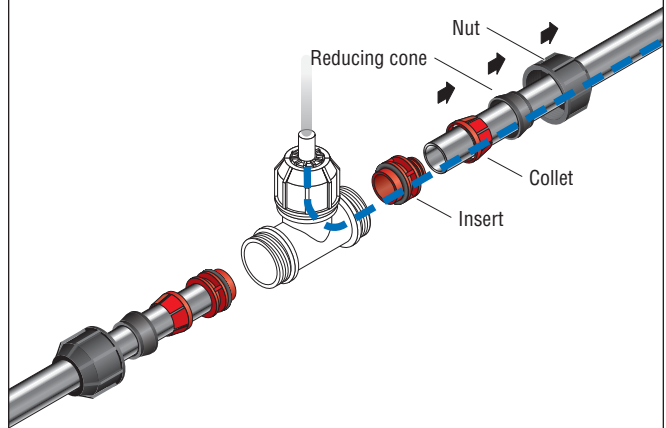

5.2A Installing an ID Philmac Fitting

- Tap insert into pipe preferably with a forked flat object. Ensure O-ring is correctly positioned on the insert. Take care not to hit or nick cable jacket.

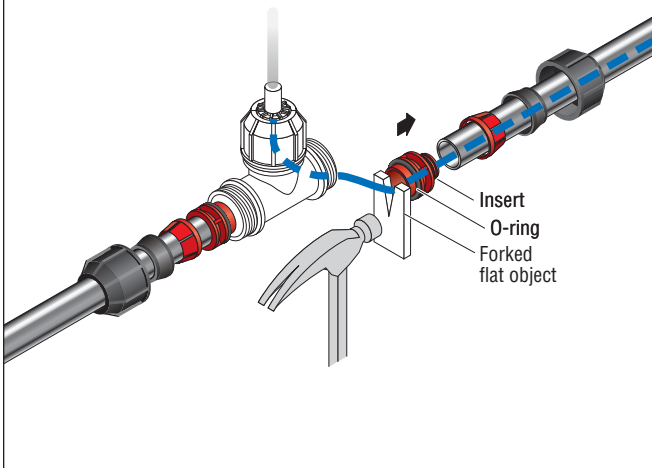

5.3A Installing an ID Philmac Fitting

- Push fitting onto pipe with insert and O-ring. Slide split collet and nut up to the fitting and engage thread. Tighten with a wrench.

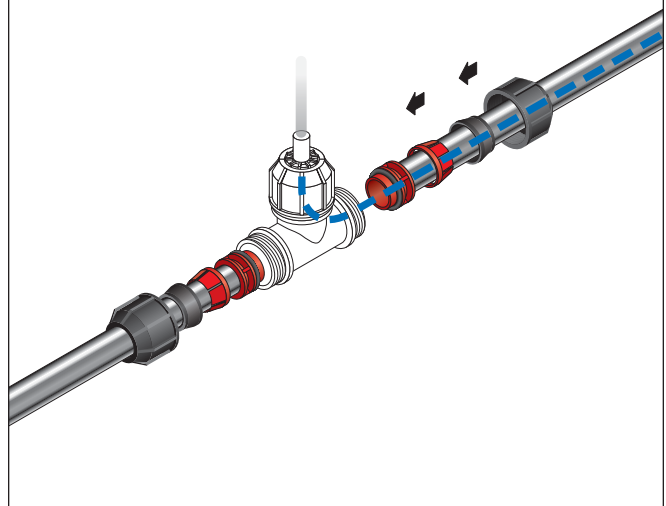

5.4A Installing an ID Philmac Fitting

- Repeat for other side.

NOTE: DO NOT tighten nut where electrical comes out as this is done in factory.

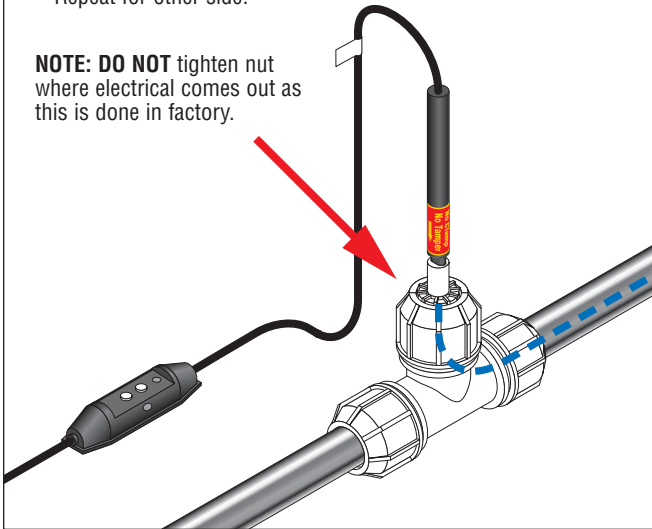

5.1B Installing an CTS/IPSOD Philmac Fitting

- Cut pipe square and deburr.
- Loosen nuts to expose 2 threads but do not remove from tee.

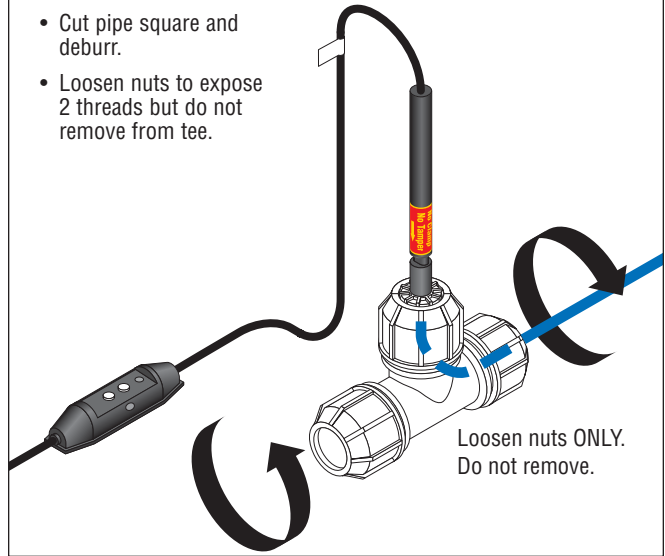

5.2B Installing an CTS/IPSOD Philmac Fitting

- Push pipe into Philmac body to stop mark indicated on outside of tee. Tighten nut with wrench.

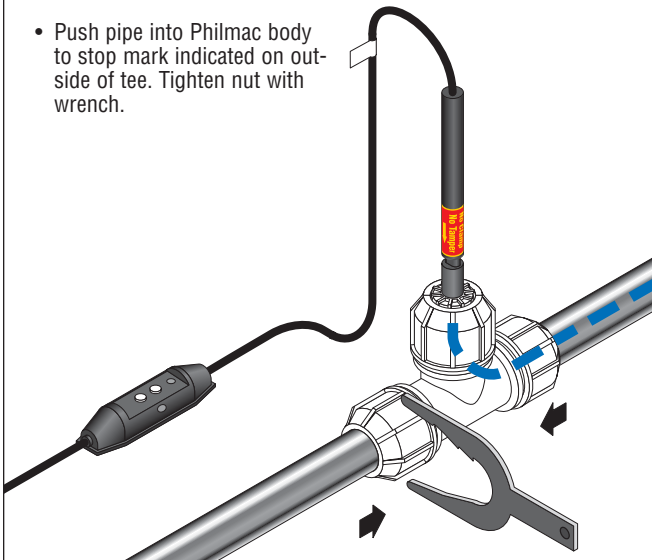

6

- If used, remove the 6' leader. Cut off the knot and remove from pipe by pulling on the side that moves easiest. Remove (see inset).

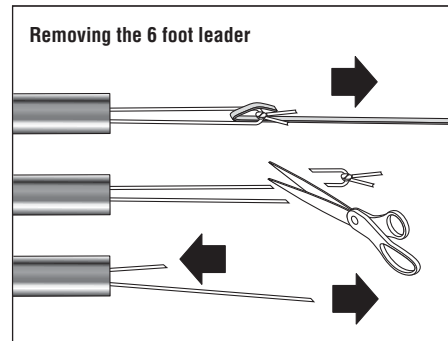

7

- After all plumbing fittings have been completely installed, a licensed trades-person should observe the installation and certify that the Philmac fitting has made a secure compression. Pressure testing the system prior to service is highly recommended to ensure a proper connection.

Refer to control devices and insulation installation on page 16.

- **It is now time to energize your Retro-Line system. Carefully follow the Electrical System Check instructions on Page 14/15.**

Ground-faulted plug-in (GFC) model shown.

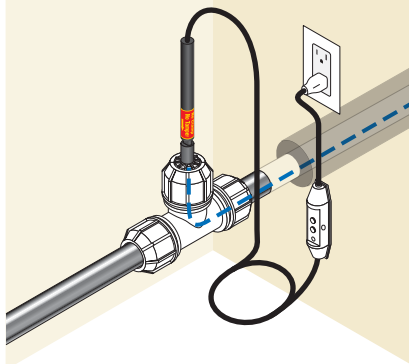

Cord set (CS) model shown. GFCI circuit protection required.

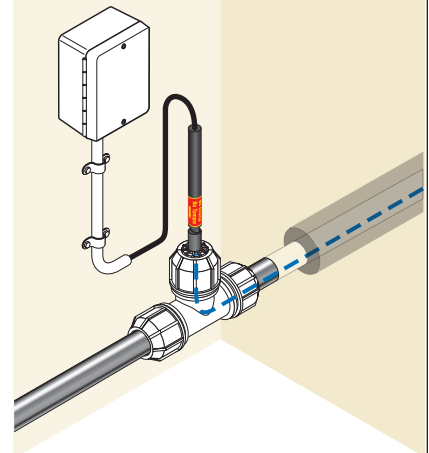



Retro-Line IP

Internal Freeze Protected Water Supply Systems

Installation Instructions



Description

The Retro-Line IP is supplied with a male adapter (MIPT) of a specific thread size to interface into any pipe material such as polyethylene, PEX, copper, PVC, ABS, iron or galvanized through a tee or wye fitting. Thread size must be determined at time of order. See part numbers below.

Always be certain there are no sharp edges in metal pipes and always ream them smooth.

Note: For pipe diameters larger than 2" ID see Heat-Line's Retro-FM system.

Kit Contents

Qty	Description
1	Retro-Line IP – Predetermined length (GFC shown)
1	Optional Cord-Set (CS) power connection

Optional Accessories

HLJ-STAT	NEMA 1 General Purpose 120V only plug-in Thermostat
HLA-120	NEMA 1 General Purpose 120V only plug-in Thermostat
GFA-STAT	NEMA 4X Ground Fault Protected Adjustable Thermostat 120V/240V 30 amp
MA-10	GFCI/ELCI Electrical Equipment Protection Device
INSUL-1.00	Closed cell polyethylene insulation sleeve for 1" ID pipe (6' long, 1 5/8" ID, 3/4" thick wall)
INSUL-1.25	Closed cell polyethylene insulation sleeve for 1 1/4" ID pipe (6' long, 1 7/8" ID, 3/4" thick wall)
INSUL-2.00	Closed cell polyethylene insulation sleeve for 2" ID pipe (6' long, 2 5/8" ID, 3/4" thick wall)

Retro-Line IP Ordering Chart

Product		Fitting Size		Cord-Set Type		Length of Heater	
RL	120 volt Retro-Line	100	Male adapter thread size 1.00" NPT	GFC	Ground fault protected	6 – 230 feet	3 watt / 120V systems
RL2	240 volt Retro-Line	125	Male adapter thread size 1.25" NPT	5-15P	120V / 6-15P 240V	6 – 550 feet	3 watt / 240V systems
		150	Male adapter thread size 1.50" NPT	CS	Cord connected (No GFCI)		
		200	Male adapter thread size 2.00" NPT	IP	Denotes male adapter fitting		

Example: **RL – 100 – 100 – IP – CS**

NOTE: The heating cable is measured and cut to the length of system ordered. Some of this length will remain within the interface fitting.

For pipe diameter 3/4" ID, order with a 1" male adapter NPT thread.
 For pipe diameters larger than 2" ID see Heat-Line's Retro-FM system.

Retro-Line IP Installation

1

- Carefully remove your Retro-Line system. It comes complete with all parts as required pre-assembled, enclosed inside of the reel. Units less than 40 feet not supplied on reel.



- It is recommended that a single circuit (15 amp) be installed by a qualified person for dedicated use of the Retro-Line system. **Do not use extension cords.**

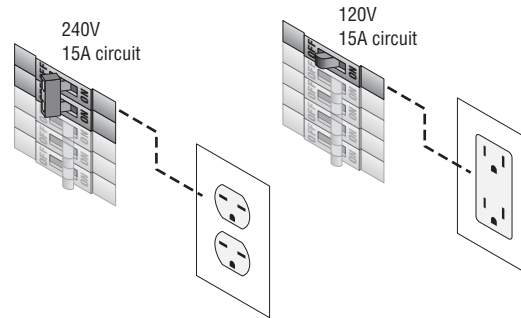

2

- Install tee fitting with appropriate female thread (FIPT) to interface to supplied Retro-Line (MIPT) thread.
- Smooth and deburr all connections, tube and pipe.**
- It is recommended that the heating cable to be installed straight through the tee as shown (water flows through at 90 degrees) instead of installing heating cable through branch.

Note: Do not install the Retro-Line fitting connection junction point in a manner that would render the system non-serviceable. Consult Heat-Line with questions regarding installation parameters with respect to serviceability.

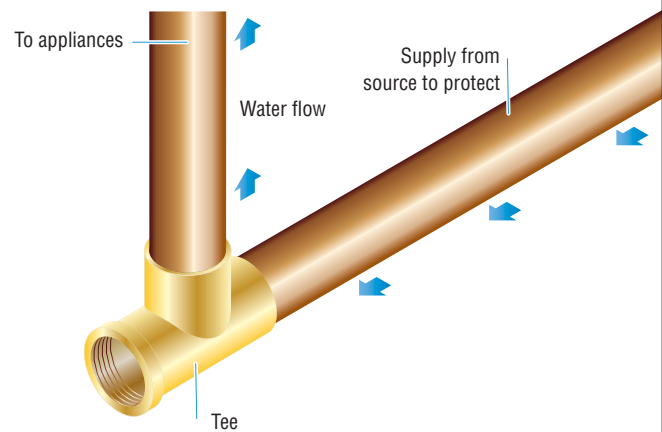

3

- Short Retro-Line systems may be pushed in without the use of a fish tape or rope. Longer systems may require the use of a fish tape or other installation method. For long systems a vacuum can be used to draw a sponge "mouse" through the pipe with a 1/8" mason line attached. These sponges can be hand made or purchased from Heat-Line. Extra long systems may require "cutting in" a coupling or series of couplings to provide access points to pull in the Retro-Line. When this is required it is important to use a Philmac[®] coupling furnished by Heat-Line.
- A 6 foot leader is provided with all Retro-Line systems over 90 feet. This leader is your point of attachment for pulling in the Retro-Line. If the leader is not required, remove it and simply push in the Retro-Line into the pipe.
- A non-toxic (potable) lubricant can be used to make cable insertion or pushing of long lengths easier.

NOTE: Retro-Line systems in reasonably straight runs up to 150 feet can most often be pushed all the way in without pulling. The Retro-Line leader is only provided as an aid to pulling. It is unable to withstand extremely hard pulls and will break if overstressed. Heat-Line will not be responsible should this occur.

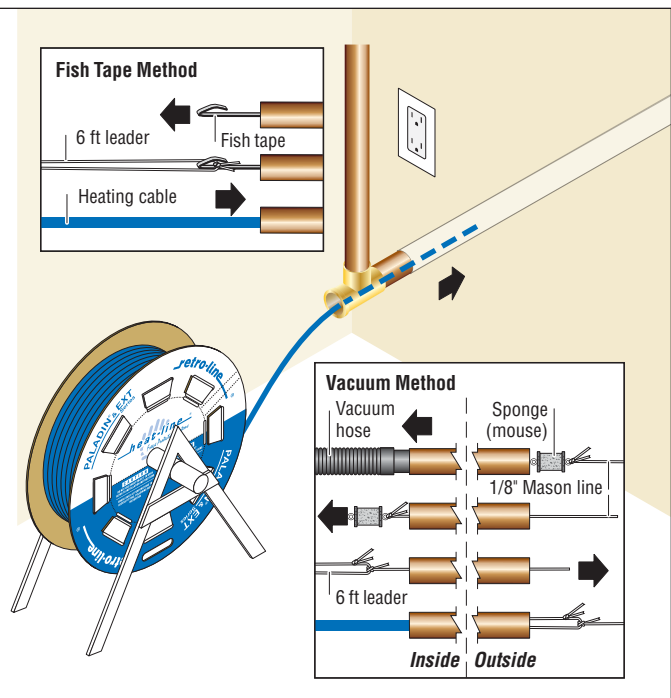

4

- Slowly push/pull the Retro-Line into the pipe off of the reel. Upon total heater insertion, break open the reel at perforations, or lift tabs to remove lid as shown.
- **Do not use sharp instruments.** Finish insertion of the Retro-Line until the Philmac fitting comes up tight. A non-toxic (potable) lubricant can be used to make cable insertion or pushing of long lengths easier. If the pipe is straight and downhill the systems can often be pushed more than 150 feet.

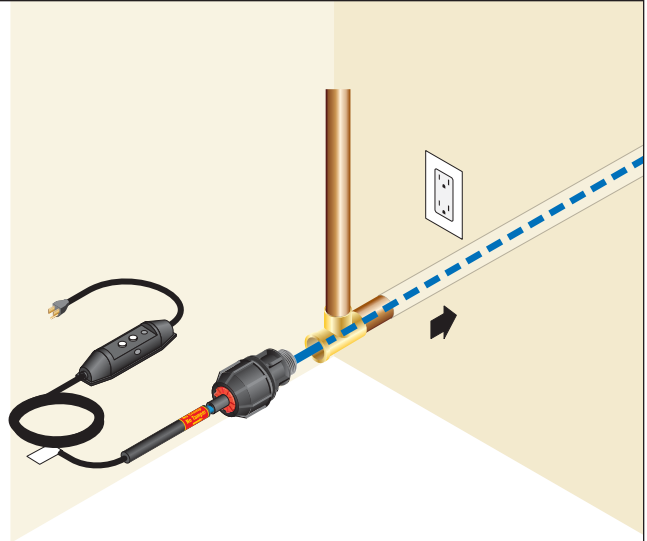

5

- Remove nut from male adapter body
- Install Teflon tape or thread compound on thread

CAUTION: Be sure there are no sharp edges - deburr all.

- Thread male adapter body into tee fitting
- Apply non-toxic lubricant or grease to top section of rubber sealing grommet.
- Slide remaining heater into pipe and tighten nut onto adapter.

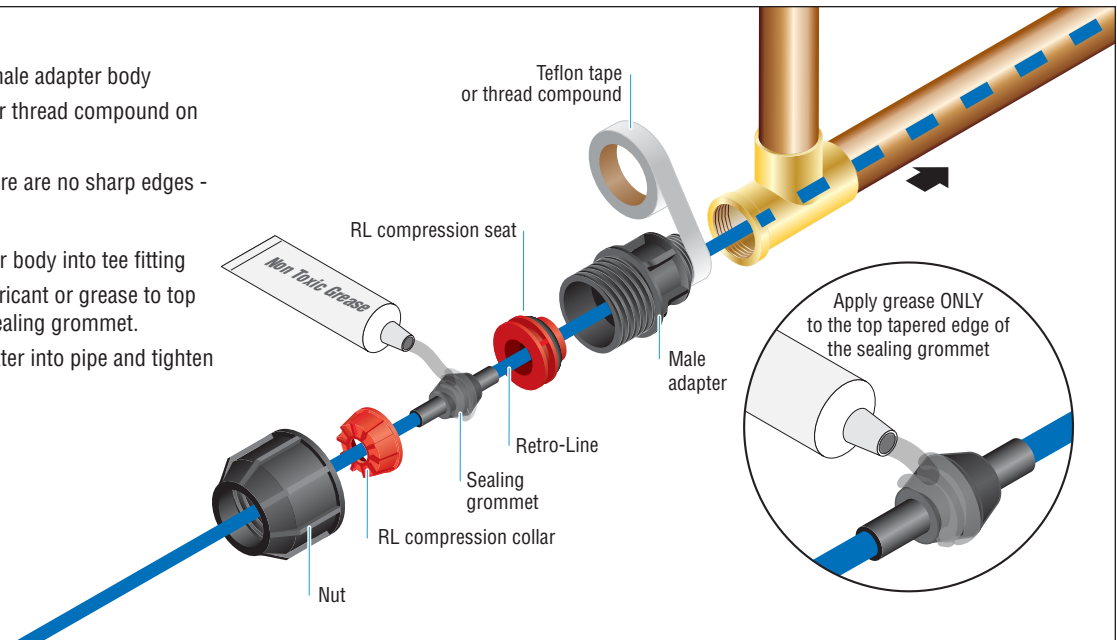

6

- Tighten nut until RL compression collar stands proud 3/16".

IMPORTANT: Ensure that the heating cable does not twist in the sealing grommet as the nut is tightened.

Note: Do not over tighten! Should be tightened by hand however a wrench can be used if assistance is required.

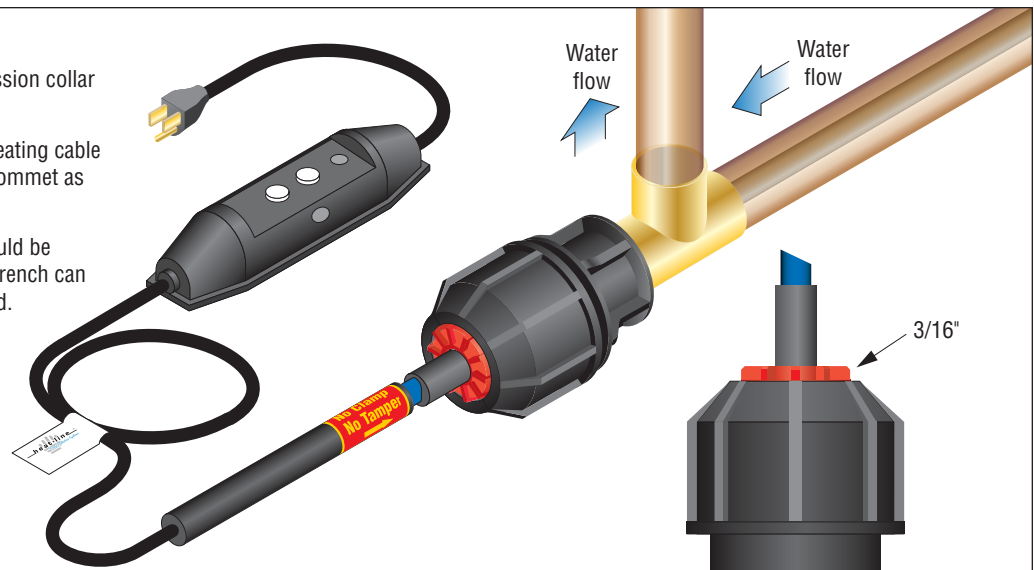

7

- If used, remove the 6' leader. Cut off the knot and remove from pipe by pulling on the side that moves easiest.
- After all plumbing fittings have been completely installed, check the operation of the pressure system.

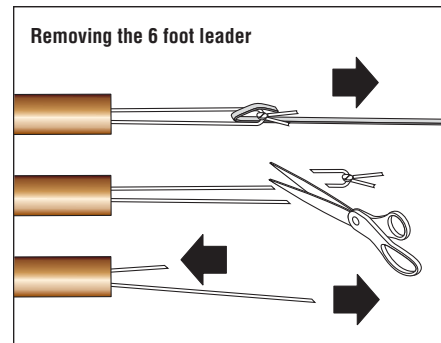

8

- After all plumbing fittings have been completely installed, a licensed trades-person should observe the installation and certify that the Philmac fitting has made a secure connection. Pressure testing the system prior to service is highly recommended to ensure a proper connection.

Refer to control devices and insulation installation on page 16.

- **It is now time to energize your Retro-Line system. Carefully follow the Electrical System Check instructions on Page 14/15.**

Ground-faulted plug-in (GFC) model shown.

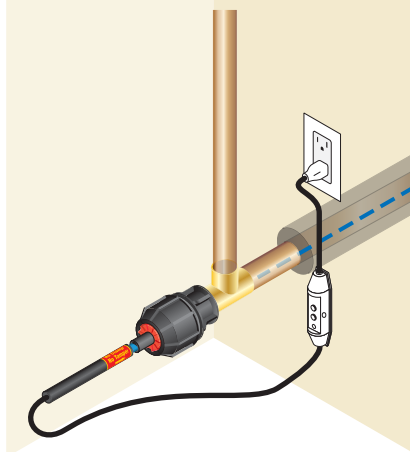

Cord set (CS) model shown. GFCI circuit protection required.

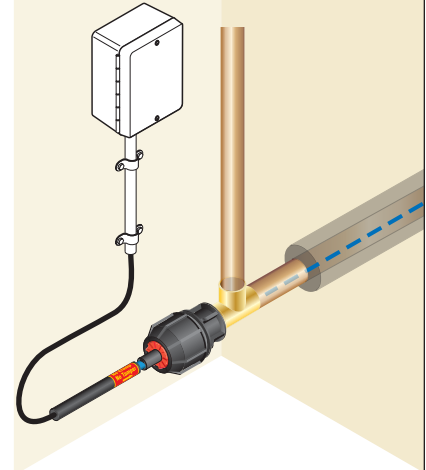



Retro-Line NI

Freeze Protected Water Supply Systems

Installation Instructions

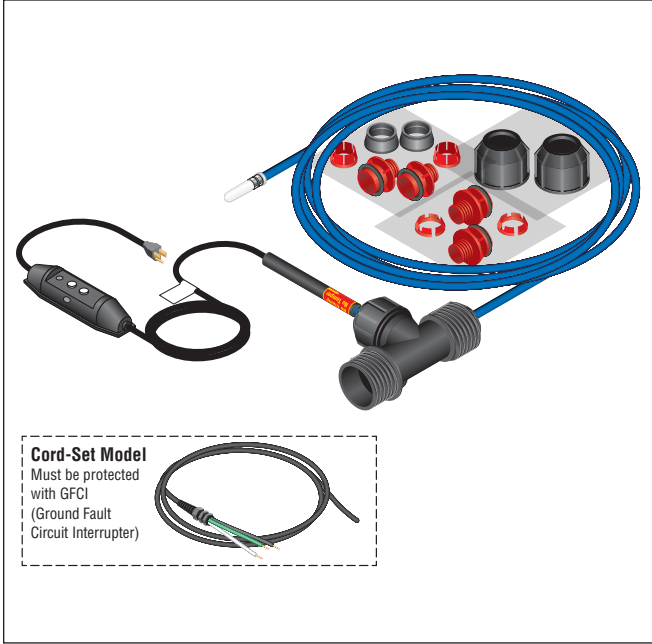

Description

The Retro-Line NI is supplied with a compression tee fitting and inserts to interface into 1" or 1 1/4" ID polyethylene pipe. See part numbers below.

Kit Contents

Qty	Description
1	Retro-Line NI – Predetermined length (GFC shown)
1	Optional Cord-Set (CS) power connection

Optional Accessories

HLJ-STAT	NEMA 1 General Purpose 120V only plug-in Thermostat
HLA-120	NEMA 1 General Purpose 120V only plug-in Thermostat
GFA-STAT	NEMA 4X Ground Fault Protected Adjustable Thermostat 120V/240V 30 amp
MA-10	GFCI/ELCI Electrical Equipment Protection Device
INSUL-1.00	Closed cell polyethylene insulation sleeve for 1" ID pipe (6' long, 1 5/8" ID, 3/4" thick wall)
INSUL-1.25	Closed cell polyethylene insulation sleeve for 1 1/4" ID pipe (6' long, 1 7/8" ID, 3/4" thick wall)

Retro-Line NI Ordering Chart

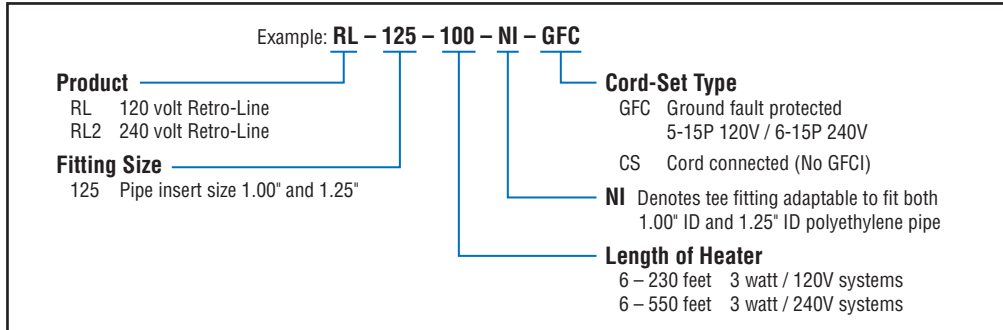

NOTE: The heating cable is measured and cut to the length of system ordered. Some of this length will remain within the interface fitting.

Retro-Line NI Installation

1

- Carefully remove your Retro-Line NI system. It comes complete with all parts enclosed inside the box, the tee body is enclosed inside the reel. Units less than 40 feet are not supplied on reel.

- It is recommended that a single circuit (15 amp) be installed by a qualified person for dedicated use of the Retro-Line system. **Do not use extension cords.**

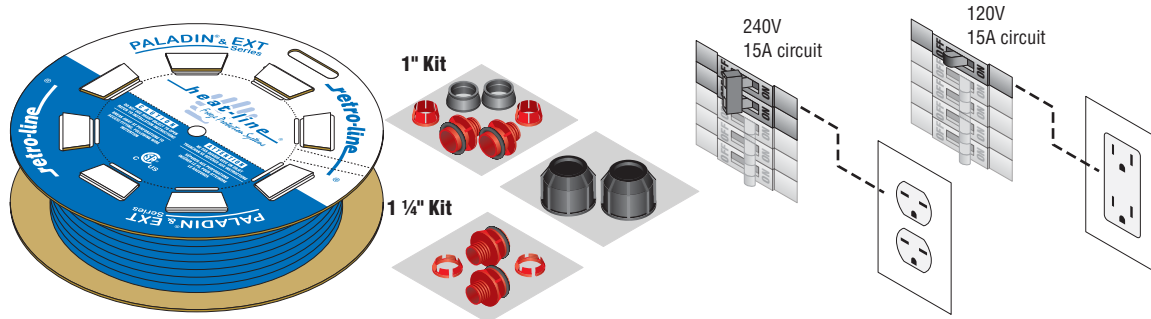

2

- Determine point of entry into the pipe. Your Retro-Line system is ordered by system (pipe) length. (See Retro-Line Ordering Instructions on page 10).
- Cut out a section of the pipe to gain access, preferably on the inside of the building and near your power supply. (Reference chart below)

CAUTION: Care must be taken not to cut the pipe too short as it is necessary to draw the pipe into the fitting when making a joint.

Note: Do not install the Retro-Line tee connection junction point in a manner that would render the system non-serviceable. Consult Heat-Line with questions regarding installation parameters with respect to serviceability.

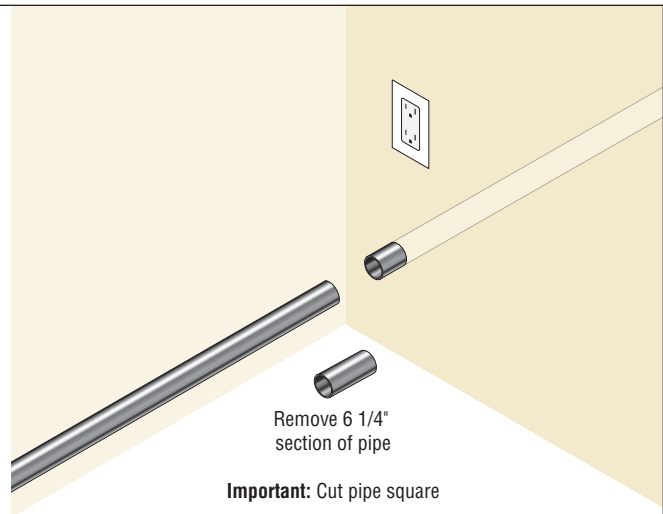

Important: Cut pipe square

3

- Measure the internal diameter of the polyethylene pipe and determine if it is 1 inch or 1-1/4 inch.

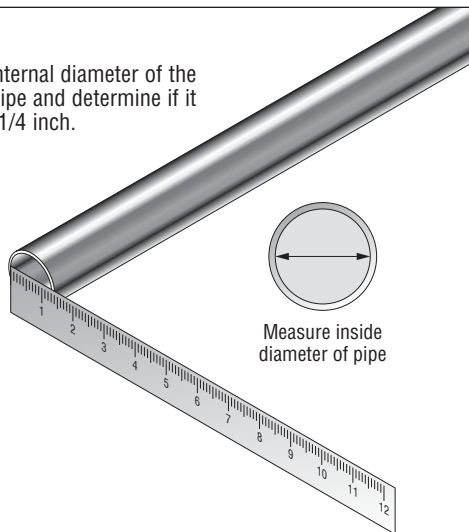

4

- Select the appropriate inserts for the pipe size but **DO NOT** insert them at this time.

1\"/>

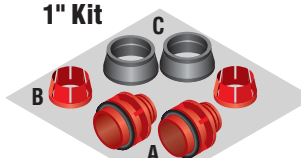

- A 2 Red inserts
- B 2 Red collets
- C 2 Reducing cones

1 1/4\"/>

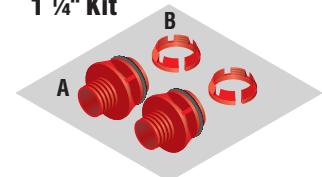

- A 2 Red inserts
- B 2 Red collets

Retro-Line Installation

5

- Slide the large black nut, reducing cone (1" only), and the red collet onto the pipe being freeze protected.

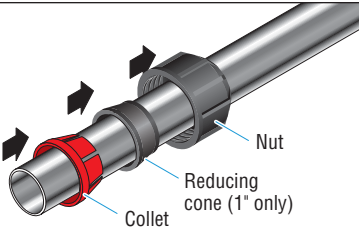

- If the pipe is within a sleeve coming up through the floor be sure to fill the conduit void with a rag during this process to prevent the nut from sliding into the conduit. You may not be able to get it back!

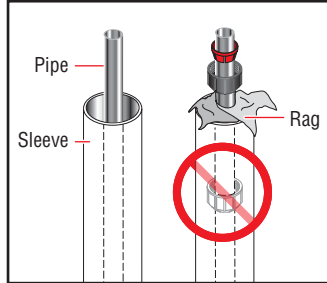

6

- Press in both inserts.

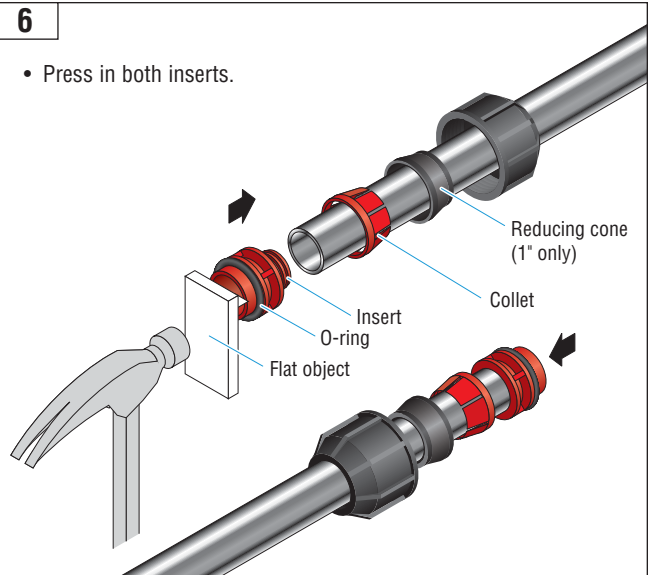

7

- Short Retro-Line systems may be pushed in without the use of a fish tape or rope. Longer systems may require the use of a fish tape or other installation method. For long systems a vacuum can be used to draw a sponge "mouse" through the pipe with a 1/8" mason line attached. These sponges can be hand made or purchased from Heat-Line. Extra long systems may require "cutting in" a coupling or series of couplings to provide access points to pull in the Retro-Line. When this is required it is important to use a Philmac® coupling furnished by Heat-Line.
- A 6 foot leader is provided with all Retro-Line systems over 90 feet. This leader is your point of attachment for pulling in the Retro-Line. If the leader is not required, remove it and simply push in the Retro-Line into the pipe.
- A non-toxic (potable) lubricant can be used to make cable insertion or pushing of long lengths easier.

NOTE: Retro-Line systems in reasonably straight runs up to 150 feet can most often be pushed all the way in without pulling. The Retro-Line leader is only provided as an aid to pulling. It is unable to withstand extremely hard pulls and will break if overstressed. Heat-Line will not be responsible should this occur.

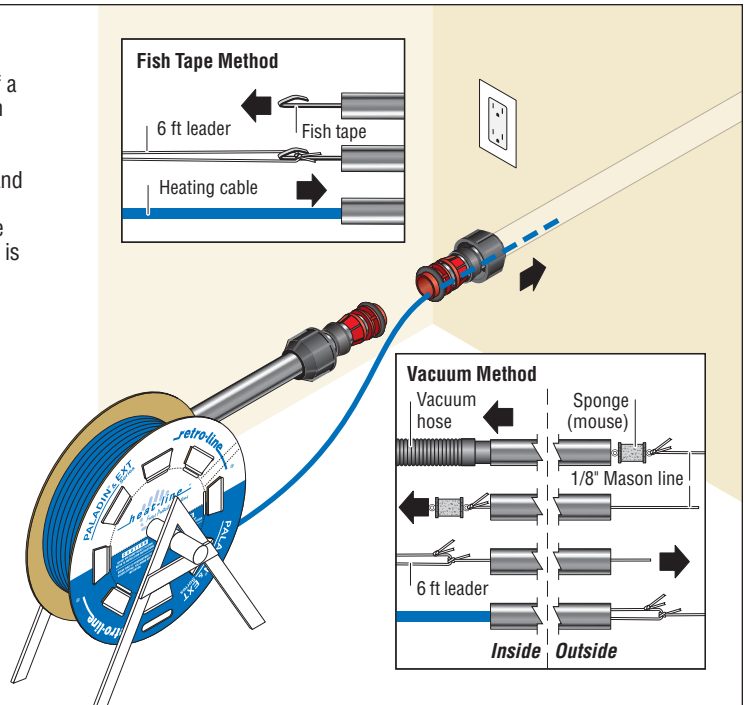

8

- Slowly push/pull the Retro-Line into the pipe off of the reel. Upon total heater insertion, break open the reel at perforations, or lift tabs to remove lid as shown.
- Do not use sharp instruments.** Finish insertion of the Retro-Line until the Philmac fitting comes up tight.

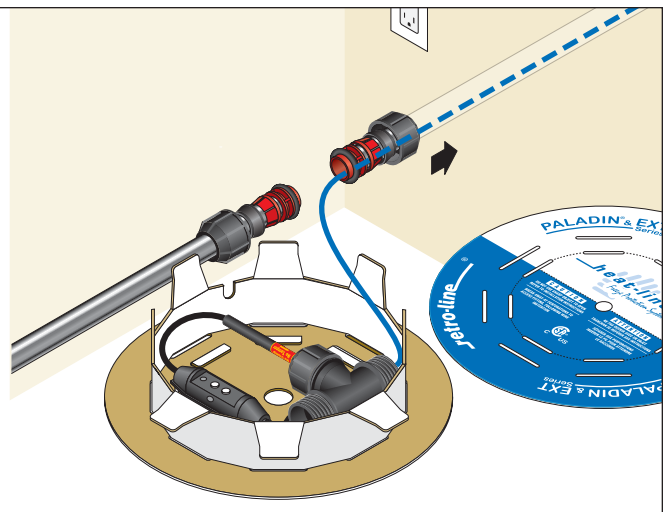

9 Installing a Philmac Fitting

- Push fitting onto pipe with insert and O-ring. Slide split collet and nut up to the fitting and engage thread.

NOTE: DO NOT tighten nut where electrical comes out as this is done in factory.

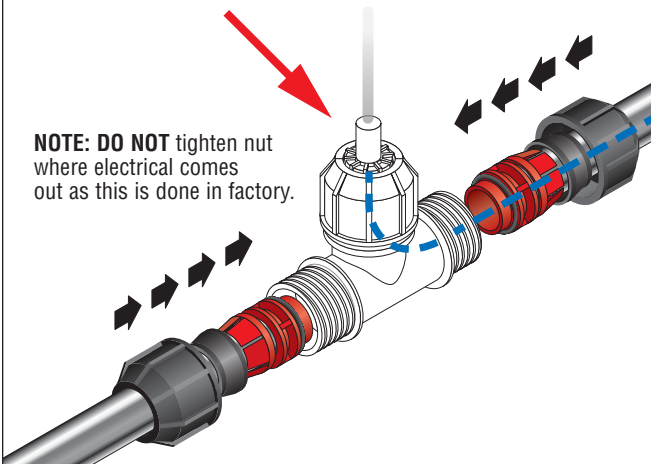

10

- Engage Tee fitting into place and tighten the black nut hand tight. Then tighten with a wrench. Do not over tighten. It is an O-ring fitting.

NOTE: DO NOT tighten nut where electrical comes out as this is done in factory.

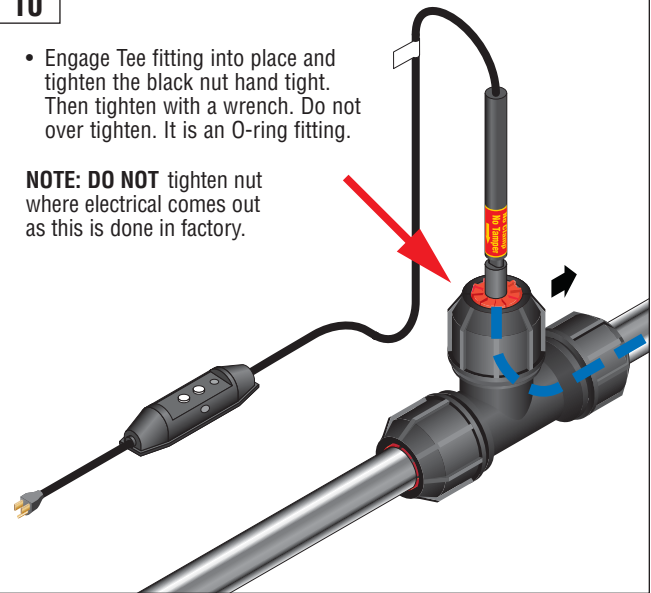

11

- If used, remove the 6' leader. Cut off the knot and remove from pipe by pulling on the side that moves easiest.
- After all plumbing fittings have been completely installed, check the operation of the pressure system.

Removing the 6 foot leader

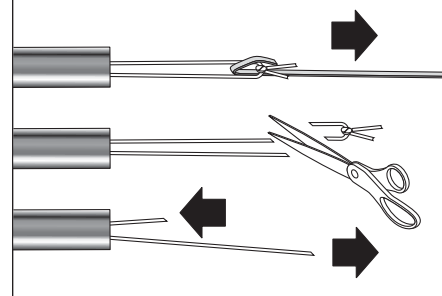

12

- After all plumbing fittings have been completely installed, a licensed trades-person should observe the installation and certify that the Philmac fitting has made a secure compression. Pressure testing the system prior to service is highly recommended to ensure a proper connection.

Refer to control devices and insulation installation on page 16.

- **It is now time to energize your Retro-Line system. Carefully follow the Electrical System Check instructions on Page 14/15.**

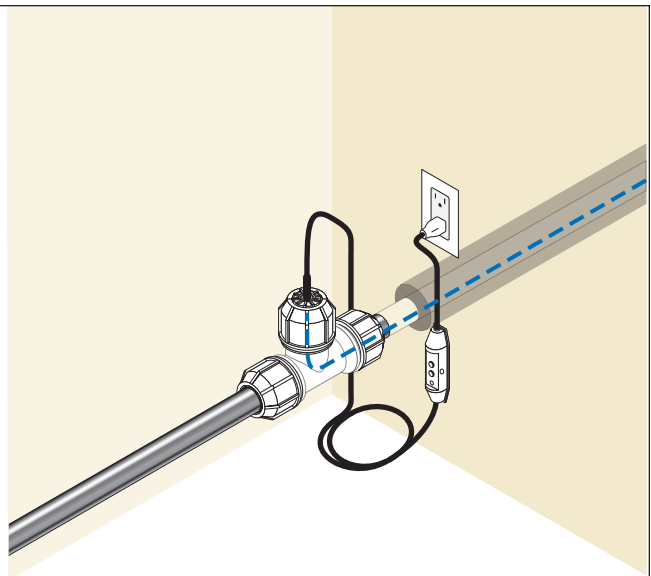

Electrical System Connection

Electrical Connection for GFC (Ground Fault Plug-in) Models

- A. Unpack the Retro-Line system plug from its protective package.
- B. Plug into your dedicated outlet. 120V 5-15R outlet for 120V systems or 240V 6-15R outlet for 240V systems.
- C. Push reset button on the cord set ground fault device until light comes ON. If light does not illuminate check power to outlet. Do not remove or tamper with the cord set. If used with a thermostat it may be necessary to bypass the thermostat control and plug directly into receptacle to perform test.
- D. Push test button and light will go OFF. This indicates that the electrical circuit is intact and fully protected.
- E. Push reset button again and light will come ON. This indicates that your Retro-Line is working.
- F. Follow this test procedure before each season and monthly while in use.

Your Retro-Line is now fully functional.

If at any time your Retro-Line system fails to work call your local electrician or Heat-Line for assistance at 1-800-584-4944.

Unplug when not in use.

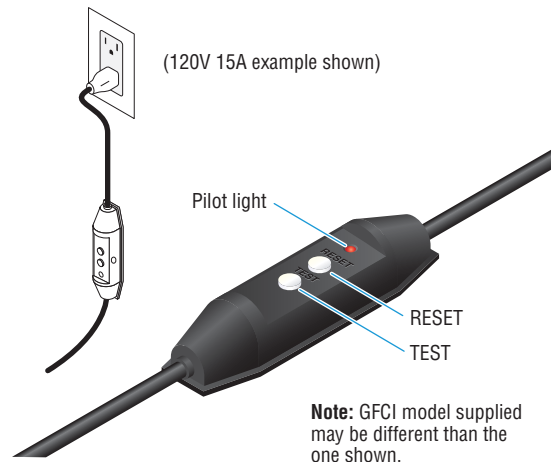

Electrical Connection for CS (Cord-Set) Models into Junction Box

Note: The "CS" version is designed to be installed by a qualified electrician and must be inspected by the governing electrical authority following completion of installation.

- A. Ensure the Retro-Line system will be operated on a dedicated ground fault protected circuit with over-current protection appropriate for the circuit conductor size and heating cable length.
- B. Confirm power is disconnected at the power supply prior to proceeding.
- C. Remove approved junction box cover.
- D. Route the Retro-Line cord-set wires into box with the supplied strain relief fitting.
- E. Connect appropriate wires together using approved wire nuts. Match wires white to white, black to black, and green to green. In the case of a metal junction box/enclosure, match green to ground screw and confirm screw is tight and secured afterward.

- F. Double check that the wires have been connected correctly and tight.
- G. Install junction box cover.
- H. Establish power to the circuit and test/reset the ground fault device for proper operation.
- I. Test the GFCI at the breaker before each season and monthly while in use.

Your Retro-Line system is now fully functional.

If at any time your Retro-Line system fails to work call your local electrician or Heat-Line for assistance at 1-800-584-4944.

Non-Metal Junction Box

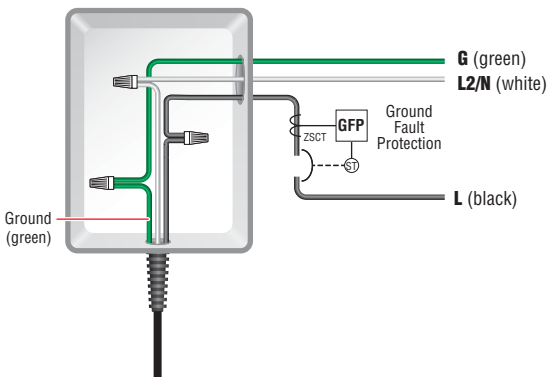

Metal Junction Box

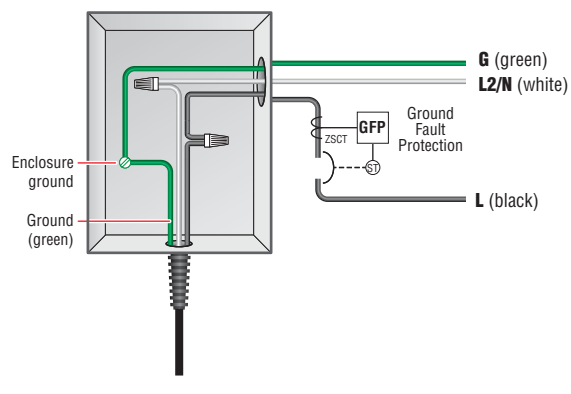

Electrical Connection for CS models installed with the optional GFA-STAT (FPT-130)

- A. Ensure the Retro-Line system will be operated on a dedicated circuit with over-current protection appropriate for the circuit conductor size and heating cable length.
- Note:** GFA-STAT (FPT-130) includes ground fault protection.
- B. Confirm power is disconnected at the power supply prior to proceeding.
- C. Remove front cover of the GFA-STAT.
- D. Remove black strain relief from the Retro-Line power cord.
- E. Route the Retro-Line cord-set wires through strain relief fitting supplied with the GFA-STAT.
- F. Follow electrical guidelines per the GFA-STAT (FPT-130) manual included with your GFA-STAT unit.**
- G. Double check that the wires have been connected correctly.
- H. Establish power to the circuit and test/reset the ground fault device for proper operation.
- I. Test the GFA-STAT GFCI before each season and monthly while in use.

Your Retro-Line system is now fully functional.

If at any time your Retro-Line system fails to work call your local electrician or Heat-Line for assistance at 1-800-584-4944.

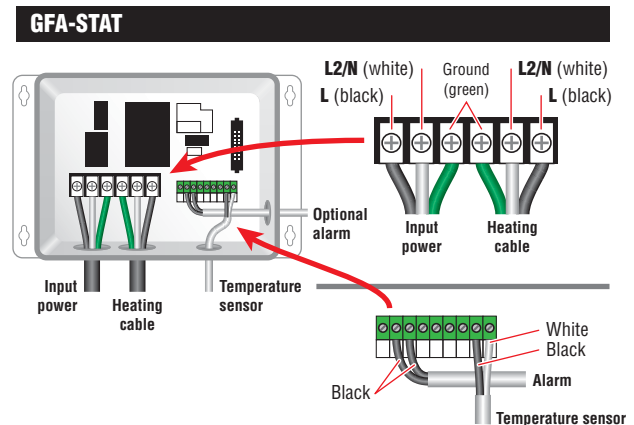

Control Devices and Insulation Installation

Control devices are not required to operate the heating cable system. They can be added for energy efficiency.

Thermostats are used to duty cycle the system in an on/off operation saving power consumption and maintain a certain pipe temperature. A sensor lead must be placed on the coldest section of pipe.

Timers are used to duty cycle the system in an on/off operation based on preset time intervals to save on power consumption.

Insulation is recommended for all new pipe installations, even where the pipe is to be buried.

For existing pipe applications, insulation is only required where the pipe is exposed to ambient outdoor temperatures, and/or where the pipe is above the ground. Insulation aids in heat retention making the heating cable more energy efficient and providing cold weather reliability.

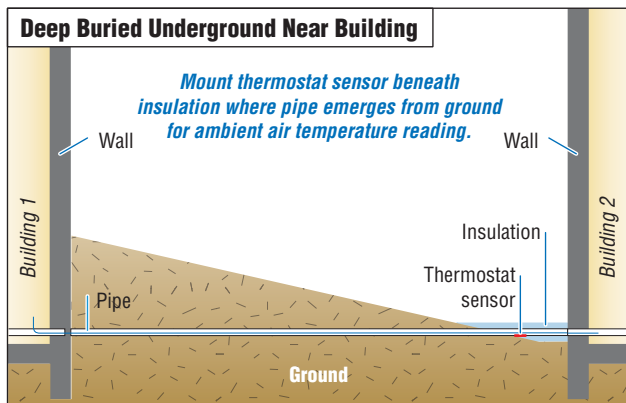
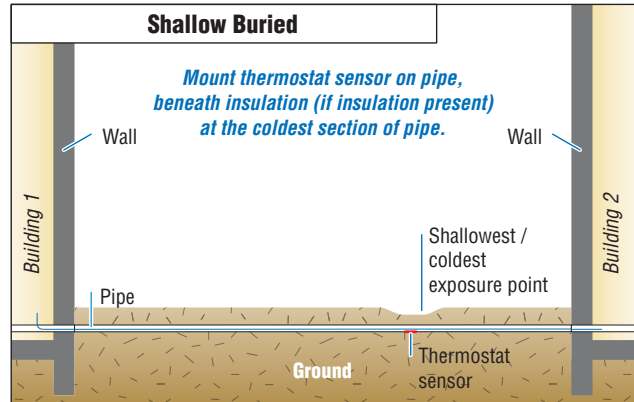
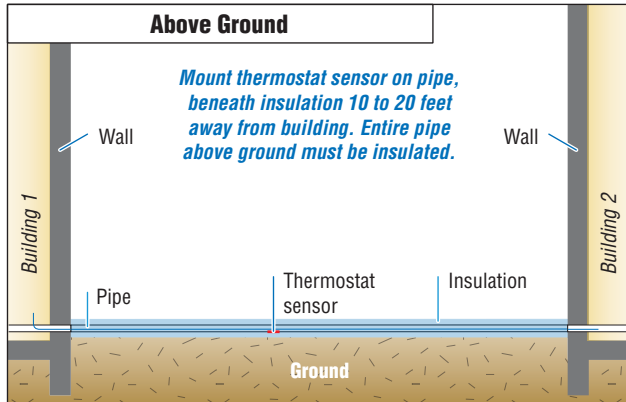
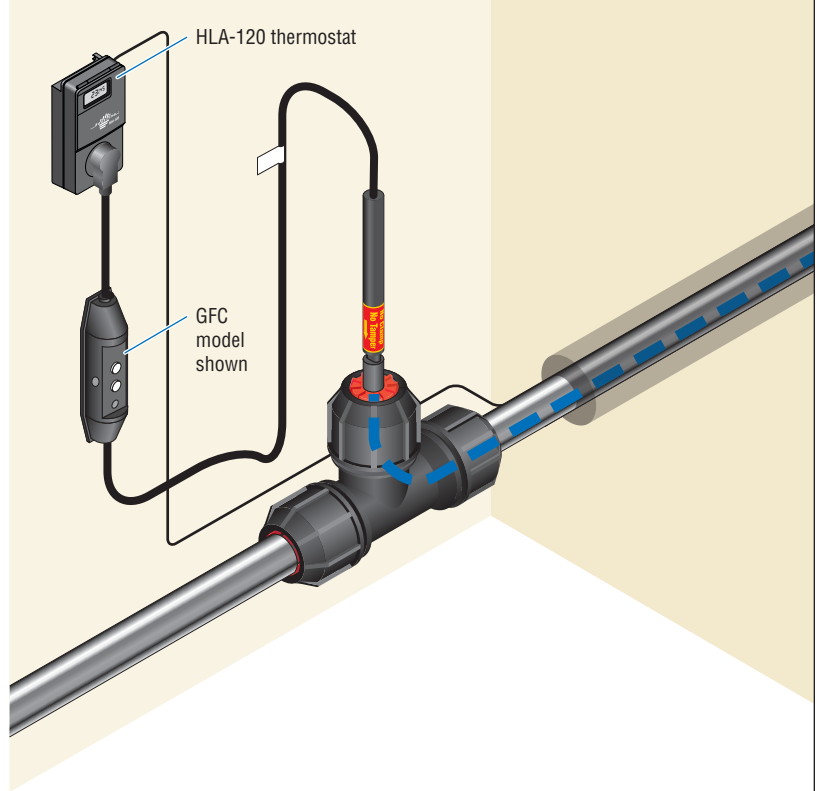

Weighting/Ballasting Water Pipes in Lakes

Note: There are various methods of weighting pipes down, but we have noted the “Pre-mixed Concrete Bag Method” to be a great option. A simple and excellent alternative to stones, blocks and other methods.

Rationale: The pre-mix concrete bags are generally 66 lbs and are relatively easy to handle. The bags should be placed over pipe to hold it down.

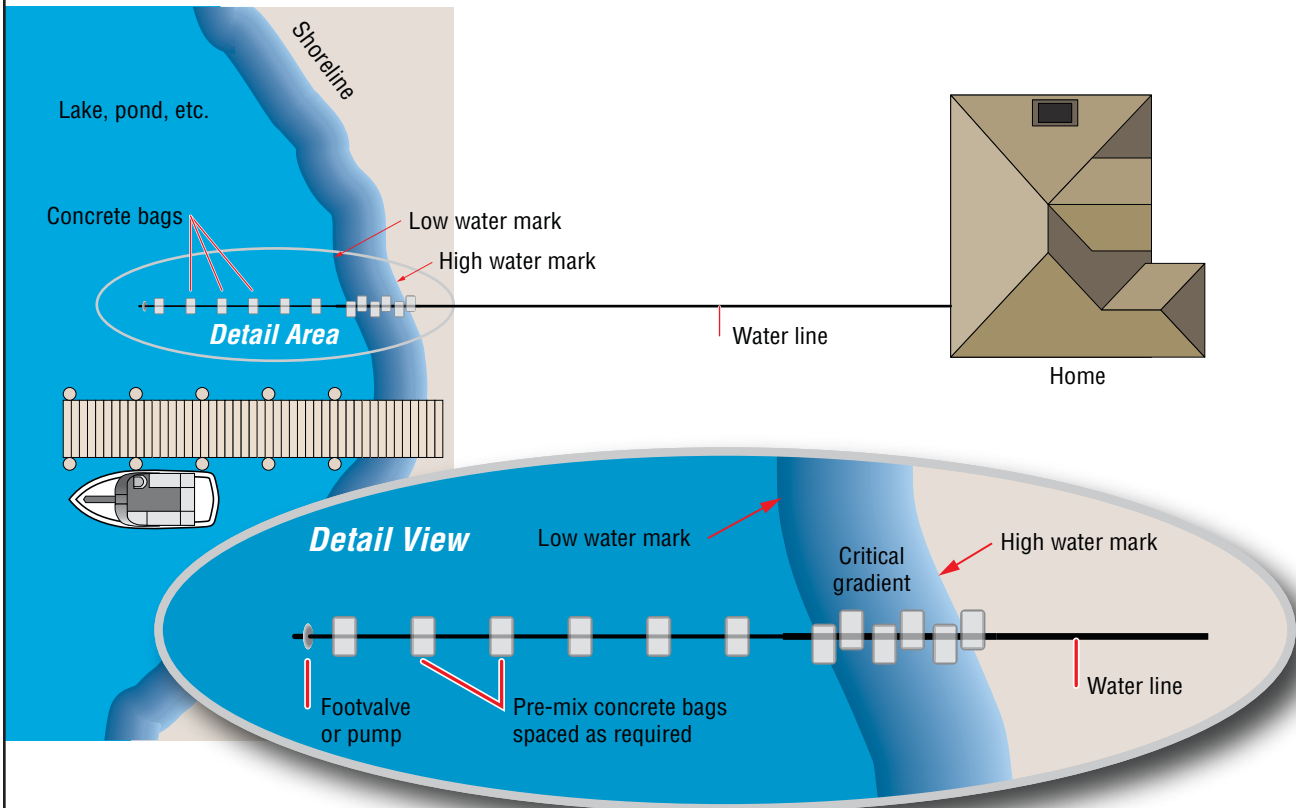

IMPORTANT

CONCRETE PRODUCTS ARE ENVIRONMENTALLY SAFE, HOWEVER, WE SUGGEST YOU CHECK WITH YOUR LOCAL AUTHORITIES BEFORE INSTALLATION. Pre-mixed concrete is packaged in plastic and paper. We recommend paper as it will naturally deteriorate and break down. Concrete bags are placed or dropped “dry” over the pipes allowing water to seep in and cure in place. When in water, straddle the pipe and drop the dry bag onto the pipe. Do not try to move the bag once dropped as it will immediately break down.

Side View

When water recedes from the high water mark to low water mark, pipe becomes exposed to atmosphere and can freeze if uninsulated. Insulation is bouyant and will float up towards the surface when water rises in the spring. 66 lb pre-mixed concrete bags will hold the pipe on the bottom when at high level.

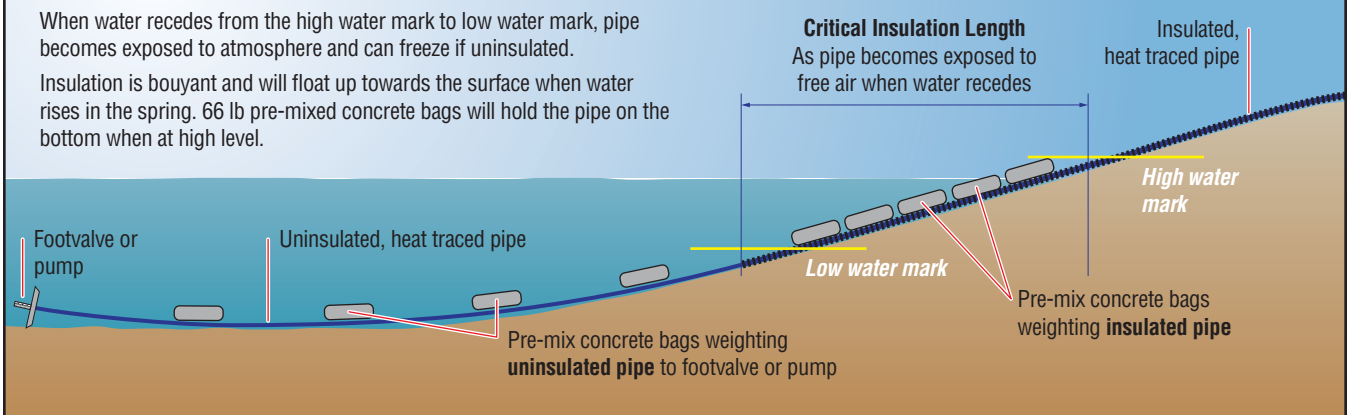

Limited Warranty

During the time periods and subject to the conditions hereinafter set forth. Heat-Line will repair or replace to the original user any portion of your Retro-Line product which proves defective in materials or workmanship of Heat-Line. Contact Heat-Line or your installer for warranty service.

At all times Heat-Line shall have and possess the sole right and option to determine whether to repair or replace defective equipment, parts or components. **Damage due to natural events or conditions beyond the control of Heat-Line are NOT COVERED BY THIS WARRANTY.**

STANDARD WARRANTY PERIOD: 60 months from date of purchase or 63 months from date of manufacture, which ever occurs first.

EXTENDED WARRANTY PERIOD: 120 months from date of purchase or 123 months from date of manufacture, which ever occurs first.

ACCESSORIES, COMPONENTS, ELECTRONICS: Not manufactured by Heat-Line, are warranted only to the extent of original manufacturer's warranty.

LABOUR, COSTS, ETC.: Heat-Line shall in **NO EVENT** be responsible or liable for the cost of field labour or other charges incurred by any customer in removing and/or re-fixing any Heat-Line product, part or component thereof.

THIS WARRANTY WILL NOT APPLY:

- (a) to defects or malfunctions resulting from failure to properly install, operate or maintain the unit in accordance with printed instructions provided,
- (b) to failures resulting from abuse, accident or negligence;
- (c) to normal maintenance services and
- (d) to parts not used in accordance with applicable local codes, ordinance and good trade practices;
- (e) if the unit is moved from its original installation location or
- (f) if the unit is used for purposes other than for what it was designed and manufactured,
- (g) to the integral ground fault device and related electronics.

PRODUCT IMPROVEMENTS: Heat-Line reserves the right to change or improve its products or any component thereof without being obligated to provide such a change or improvement for units sold and/or shipped prior to such change or improvement.

WARRANTY EXCLUSIONS: As to any Heat-Line product after the expiration of the time period of the warranty applicable thereto as set forth above. There will be no warranties including any implied warranties of merchantability or fitness for any particular purpose. No warranties or representations at any time made by any representative of Heat-Line, shall vary or expand the provisions hereof.

LIABILITY LIMITATION: In no event shall Heat-Line be liable or responsible for consequential, incidental or special damages resulting from or related in any manner to any Heat-Line product or parts thereof. In the absence of suitable proof of the purchase date, the effective date of this warranty will be based upon the date of manufacture plus 90 days.

Heat-Line Freeze Protection Systems

1095 Green Lake Road
Algonquin Highlands, ON Canada
KOM 1S0
Tel: 1-705-754-4545
1-800-584-4944
Fax: 1-705-754-4567
info@heatline.com
www.heatline.com

Heat-Line, Retro-Line, Retro-FM, Retro-DWS and CARAPACE are registered trademarks of Heat-Line Corporation. Philmac is a registered trademark of Philmac Pty Ltd.

Important: All information, including illustrations, is believed to be reliable. Users, however, should independently evaluate the suitability of each product for their particular application. Heat-Line a Division of Christopher MacLean Ltd. makes no warranties as to the accuracy or completeness of the information, and disclaims any liability regarding its use. Heat-Line's only obligations are those in the Heat-Line Standard Terms and Conditions of Sale for this product, and in no case will Heat-Line be liable for any incidental, indirect, or consequential damages arising from the sale, resale, use, or misuse of the product. Specifications are subject to change without notice. In addition, Heat-Line reserves the right to make changes—without notification to Buyer—to processing or materials that do not affect compliance with any applicable specification.



Retro-Line[®] Warranty Form

CONGRATULATIONS!

You have just purchased the most advanced internal freeze-protection system available on the market, backed by the finest warranty offered in the industry. Your Retro-Line system comes with a standard 5 year limited warranty with an optional 10 year limited warranty available.

~ The warranty applies only to the original purchaser of the product and is not transferable at any time for any reason. The warranty form must be filled out and returned to Heat-Line within 6 months of invoice date or unit manufactured date plus 9 months to be eligible for the 10 year extended warranty. ~

OWNER MAILING ADDRESS

Name _____
 Address _____

 City _____
 Prov/State _____ Postal/ZIP _____
 Country Canada USA Other: _____
 Home Phone _____
 Email _____

INSTALLATION ADDRESS (if different than mailing)

Name _____
 Address _____

 City _____
 Prov/State _____ Postal/ZIP _____
 Country _____
 Work/Cell _____

PRODUCT INFORMATION

Product Cat.# _____
 Serial # _____
 Length _____

Installation Type:
 Lake/River
 Well
 Municipal
 Other: _____

WARRANTY INFORMATION

5 Year Limited Warranty: **INCLUDED!** 10 Year Limited Warranty: \$1.75 / foot (\$75.00 minimum)

PAYMENT DETAILS FOR 10 YEAR LIMITED WARRANTY

System Length* _____ = Subtotal
 Units 1 to 550 feet = \$1.75 per foot OR \$75.00 minimum
 * For custom lengths involving inches, round up to the nearest foot
 _____ x \$ 1.75/ft _____

Taxes and Currency

If Canadian Address:
 Subtotal: _____
 Provincial Tax %: _____ Tax Due: _____
 Total in CDN Currency:

If U.S. Address or Other Country:
 No Taxes Apply
 Total in US Currency:

PAYMENT METHOD

Cheque

Enclose and make out to Heat-Line for full amount

Credit Card:

Mastercard or Visa

Name on Card: _____

Card Number: _____

Expiration Date: ____ ____

LIMITED WARRANTY

During the time periods and subject to the conditions hereinafter set forth. Heat-Line will repair or replace to the original user any portion of your Retro-Line product which proves defective in materials or workmanship of Heat-Line. Contact Heat-Line or your installer for warranty service.

At all times Heat-Line shall have and possess the sole right and option to determine whether to repair or replace defective equipment, parts or components. **Damage due to natural events or conditions beyond the control of Heat-Line are NOT COVERED BY THIS WARRANTY.**

STANDARD WARRANTY PERIOD: 60 months from date of purchase or 63 months from date of manufacture, whichever ever occurs first.

EXTENDED WARRANTY PERIOD: 120 months from date of purchase or 123 months from date of manufacture, whichever ever occurs first.

ACCESSORIES, COMPONENTS, ELECTRONICS: Not manufactured by Heat-Line, are warranted only to the extent of original manufacturer's warranty.

LABOUR, COSTS, ETC.: Heat-Line shall in **NO EVENT** be responsible or liable for the cost of field labour or other charges incurred by any customer in removing and/or reaffixing any Heat-Line product, part or component thereof.

THIS WARRANTY WILL NOT APPLY:

(a) to defects or malfunctions resulting from failure to properly install, operate or maintain the unit in accordance with printed instructions provided,

- (b) to failures resulting from abuse, accident or negligence;
- (c) to normal maintenance services and
- (d) to parts not used in accordance with applicable local codes, ordinance and good trade practices;
- (e) if the unit is moved from its original installation location or
- (f) if the unit is used for purposes other than for what it was designed and manufactured,
- (g) to the integral ground fault device and related electronics.

PRODUCT IMPROVEMENTS: Heat-Line reserves the right to change or improve its products or any component thereof without being obligated to provide such a change or improvement for units sold and/or shipped prior to such change or improvement.

WARRANTY EXCLUSIONS: As to any Heat-Line product after the expiration of the time period of the warranty applicable thereto as set forth above. There will be no warranties including any implied warranties of merchantability or fitness for any particular purpose. No warranties or representations at any time made by any representative of Heat-Line, shall vary or expand the provisions hereof.

LIABILITY LIMITATION: In no event shall Heat-Line be liable or responsible for consequential, incidental or special damages resulting from or related in any manner to any Heat-Line product or parts thereof. In the absence of suitable proof of the purchase date, the effective date of this warranty will be based upon the date of manufacture plus 90 days.

PROOF OF PURCHASE

If a proof of purchase copy is submitted with this warranty application form, the warranty period will be effective as of invoice date. In the absence of suitable proof of purchase, the effective date of this warranty will be based upon the date of unit manufacture plus 3 months.

Proof of purchase (invoice) attached: Yes No

By signing below you acknowledge you have read and understand the full limited warranty document.

Signed: _____

Dated: _____

The warranty form must be filled out and returned to Heat-Line within 6 months of invoice date or unit manufactured date plus 9 months to be eligible for 10 year extended warranty.

Heat-Line and Retro-Line are registered trademarks of Heat-Line Corporation.

Heat-Line Freeze Protection Systems

1095 Green Lake Road / Algonquin Highlands, / KOM 1S0 / info@heatline.com / www.heatline.com
ON Canada